

# Design of Optimization of Goat Sales Based Wireless Sensor Network

Taufik Indra Prasestya<sup>1</sup>, Lis Diana Mustafa<sup>2</sup>, Waluyo<sup>3</sup>

<sup>1,3</sup> Digital Telecommunication Network,

Department of Electrical Engineering, State Polytechnic of Malang, Indonesia

<sup>2</sup>Telecommunication Engineering,

Department of Electrical Engineering, State Polytechnic of Malang, Indonesia

<sup>1</sup>taufikindra232@gmail.com, <sup>2</sup>lis.diana@polinema.ac.id, <sup>3</sup>waluyo@polinema.ac.id

**Abstract** — Currently, goat farming is one of the fastest growing businesses. Developments that occur include buying and selling that can be done through e-commerce available on digital media. E-commerce can increase sales from goat breeders through complete descriptions and goat productivity. Based on the description above, it is necessary tools and systems that can help increase the productivity of goat farmers. The method used is to carry out the process of weighing goats using loadcell, measuring goat body temperatures using MLX614 temperature sensors, and RFID sensors used to detect goat ID, goat type, and weighing time. In addition, it also uses Arduino as a microcontroller and raspberry pi as a server. There are sensor nodes and server nodes where data will be sent from the arduino uno sensor server node raspberry pi 3RF24L01. Communication technique is client server designed for communication between the client node and the server so that error the data transmission smaller. The results of testing tools and systems include testing the accuracy of sensors having several sensor values such as RFID, Loadcell and temperature sensors MLX90614 with several points, namely for RFID itself it is concluded that the success rate is read 100%, for the accuracy level of the loadcell sensor with a comparison of some of the scales carried out 10, the average error was 0.77% and the testing accuracy of the MLX90614 temperature sensor with a thermogun comparison, the average error value before calibration was 7.565%, while after calibration, the average error value was 0.507%.

**Keywords**— Goat care, Feed optimization, Goats, RFID, E-COMMERCE.

## I. INTRODUCTION

Goat farming is one of the most promising businesses for livestock entrepreneurs. This is because goats have a very wide market share. Everyone definitely needs a goat for consumption and breeding [1]. Just as before the Eid al-Adha holiday, every Muslim needs a goat to be used as a sacrificial animal. In addition to holding the aqiqah, every parent who has a baby will slaughter a goat. However, based on a survey at the Karangploso goat market, selling goats in that market between sellers and buyers met directly without weighing the goats and only based on estimates to determine the selling price of the goats. So that the sale of goats does not match the actual weight of the goat because there are no special scales available to measure the weight of goats. So that it can take advantage of the load cell sensor which functions as a goat scale [2].

In addition, due to the many diseases in goats, in fact, in the traditional market for buying and selling goats, goat health insurance certificates are not given which can convince buyers that the goats are in good health. Having a goat certificate from the animal husbandry service stating the condition of the goat can build confidence between the buyer and the seller. So that a system can be created that supports goat marketing. Whereas in the current era, technology and media have become commonly used in various fields, such as marketing goat animal products through websites [2][3].

Based on these problems, a system for optimizing the sale of goats was designed to increase the efficiency of farmers in sales. In this study, a system was proposed with the title "Design of

Goat Livestock Sales Equipped Loadcell with Websites Based Wireless Sensor Network". In this research, the technology applied is to create a website selling livestock. This is intended so that buyers and sellers are connected with an integrated system [3][4]. Making it easier for both of them to carry out the buying and selling process. There are several factors that affect the increase in buying and selling power by inputting a number of things such as body weight, temperature, ID and pictures of goats that are monitored every day. To avoid cheating during the purchase process, there is a history that functions to show the history of the scales in the previous few days as a reference for purchasing the goat to be purchased [5][6]. Where in its implementation it utilizes load cell sensors which function as digital scales for livestock. Sensor load cell it is sent to the server to become one of the main inputs on website buying and selling.

## II. METHOD

### A. Research Design

The stages of the research are arranged so that this research can be carried out in detail. The stages of research that will be carried out in this study are stated in the flowchart below.

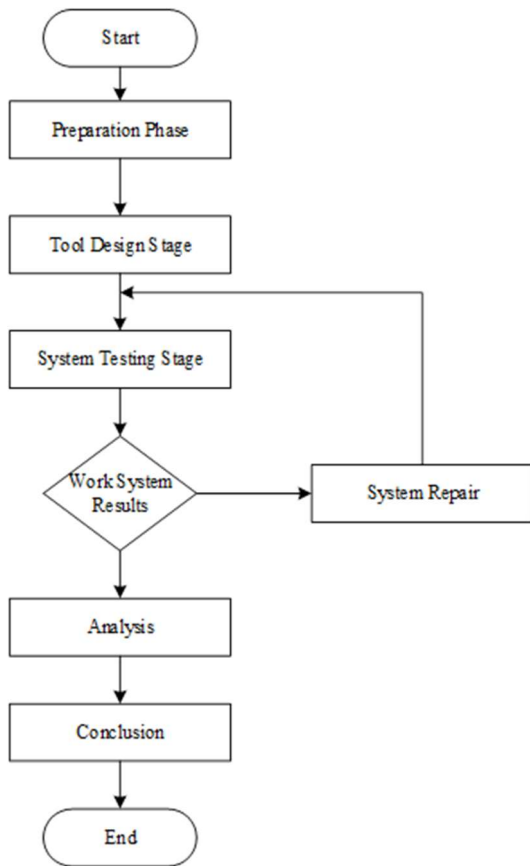

Figure 1. Research Diagram

Fig. 1 shows the stages or flow of the research design that will be carried out in making this system, as follows:

- 1) Preparation stage, looking for journal references related to the Wireless Sensor Network (WSN) theme and studying journals and concepts about WSN-based animal husbandry.
- 2) Tool planning stage, Prepare and learn what components will be used when conducting research on animal husbandry.
- 3) Website planning stage, planning is done by studying the programming language used to create the website.
- 4) The stage of making tools, carried out by making tools that have been planned with the tools that have been provided by paying attention to each component.
- 5) System testing stage, at this stage a system test is carried out to check again that the system is running properly and correctly.
- 6) Data analysis, the implementation of the system is carried out, namely the stages in making the system according to the design that has been made starting from the microcontroller program to mechanics and also electricity.
- 7) The results of the work of the system, the results of the work of this system is the last process of various stages that can be run and used for needs.
- 8) The tool is complete, the tool that has been assembled and tested is then ready for use.

9) Thesis, the making of the thesis report is carried out when all stages have been carried out and tested.

*B. System Block Diagram*

The system design shown in Fig.2 Block Diagram System Design is an overall system design where there are sensor nodes connected to the server node using the nRF24101 module as a transceiver, on the website connected to the internet to display all data that has been managed on the server [7]. The following is a block diagram of the system design:

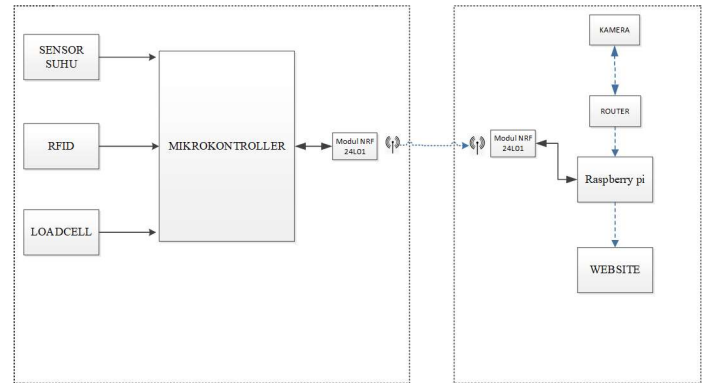

Figure 2. Block Diagram

The explanation of the block diagram of the system design of this study is as follows:

- 1) Temperature sensor as an input that functions to determine room temperature and send data to the microcontroller
- 2) RFID is an identifier for each individual goat to distinguish one goat from another. other.
- 3) Digital scales are used to weigh the goat's weight and send it to the microcontroller for processing the data.
- 4) The microcontroller is used as a container for various inputs and then processes the data to be sent to the device.
- 5) The NRF module is used for communication between the sensor node and the server node
- 6) The Raspberry pi is a data repository for all inputs that can be displayed on the website.
- 7) The router is used to connect the camera with the server to add photos on the web
- 8) The camera is used to take pictures of the goats that have been weighed and then sent to the web for reporting.
- 9) The website is used to display the identity of the goat, the price of the goat and the proportional weight of the goat.

*C. Hardware Planning*

The system design consists of a client node and a server node. The following Fig. 3 is the overall circuit of the client node while Fig. 4 is the overall series of the server node.

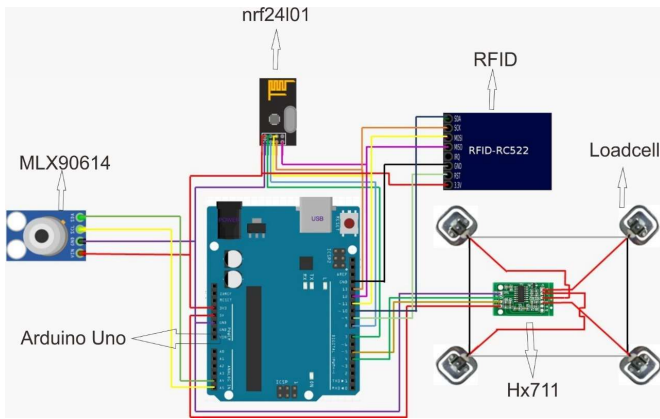

Figure 3. Hardware Planning

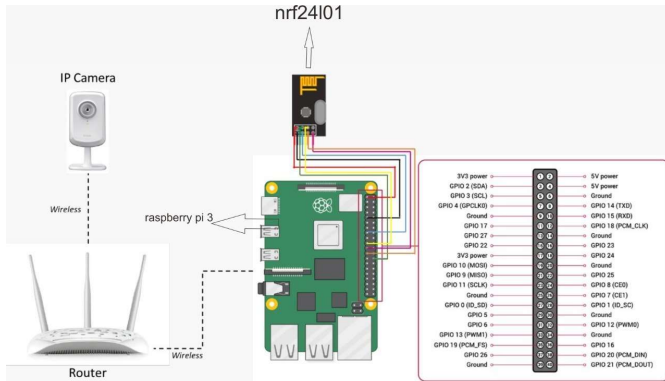

Figure 4. Hardware Planning

D. Database Planning

The database design created for this system is shown in Fig. 5.

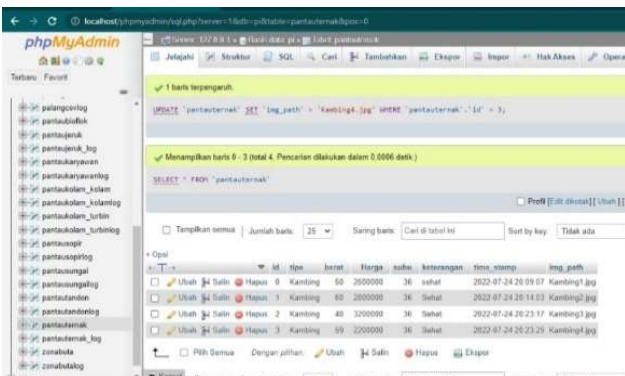

Figure 5. Database Planning

In the database that created there is a table with the name of monitoring goats which contains columns, namely ID, goat type, weight, price, temperature, description, time stamp, img path [8]. The database used this time will be displayed on the website page.

III. RESULTS AND DISCUSSION

A. Hardware Circuit Results

Referring to sub-chapter of the design of the system design is then implemented in the form of a series of devices. The following is the result of the implementation of the design.



Figure 6. Hardware Implementation of loadcell sensor, RFID, and MLX614

In Fig. 6 is an image of the loadcell sensor, RFID, and the MLX614 temperature sensor connected to the Arduino Uno microcontroller according to the datasheet [9].



Figure 7. Hardware Implementation of the RFID and MLX614

While Fig. 7 is an image of the RFID and MLX614 temperature sensor connected to the Arduino Uno microcontroller according to the datasheet [10]. Then the circuit is implemented as shown in Fig. 8.

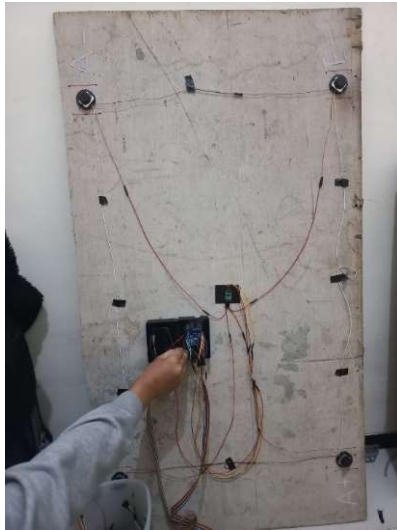

Figure 8. Implementation Hardware

TABLE 1  
COMPONENT TEST RESULTS

Process of Sending Data	Process of Sending Data	Process of Sending Data
1	Update	Successful
2	Update	Successful
3	Update	Successful
4	No Update	Failed
5	Update	Successful
6	Update	Successful
7	Update	Successful
8	Update	Successful
9	Update	Successful
10	Update	Successful
11	Update	Successful
12	Update	Successful
13	No Update	Failed
14	No Update	Failed
15	Update	Successful
16	Update	Successful
17	Update	Successful
18	Update	Successful
19	Update	Successful
20	Update	Successful

**B. Web System Test**

The following is a picture that shows the implementation of a goat livestock monitoring website that is used to sell goats based on ID, weight, temperature, and time of uploading data from goats.

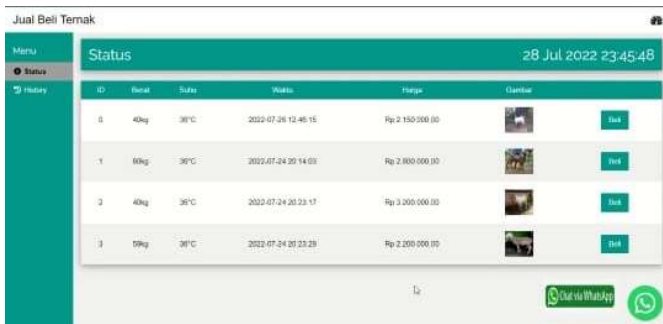

Figure 9. Implementation Web System

The following section of the main page displays the status of various conditions, namely ID, weight, temperature, time, price and an image that displays its value in real time when weighing is carried out [11]. In addition, on the website status display, reservations can be made to the owner of the goat owner.

**C. Component Test Results**

In this sub-chapter, tests are carried out which include testing the transmission of data from the sensor node to the server node in the form of an image capture process [12][13]. Based on the tests that have been carried out, the following table shows the results of data transmission, which can be seen in the following table:

In Table 1 shows data from the test results of sending data 20 times by observing the process of updating the image of the goat [14][15]. From the data above, it shows that the photo status failed to update the image of the goat 3 times so that the system also failed 3 times to display the image of the goat. So that based on the test results obtained 85% percentage of success in the process of updating and displaying images of goats on the system.

**IV. CONCLUSION**

Based on the formulation of the problem it can be concluded that:

Making goat husbandry optimization tools is done by providing an RFID Tag for each goat where each goat has an ID, weighing the goat's weight using a loadcell where the goat's weight will be integrated with website livestock monitoring

Goat scales that have been made can be integrated with website livestock monitoring by using the nRF24101 module, where the sensor node located on the hardware sends data to the server node via the nRF24101 module.

Sensor accuracy test loadcell obtained an average error of 0.77%, the RFID accuracy test obtained an RFID reader success rate in reading labels of 100%, while the MLX90614 temperature sensor test obtained an average error value of 0.507%.

The goat's weight test is carried out using a loadcell on the sensor node which functions as a goat's weight scale which then from the results of measuring the goat's weight is sent to the server node sent to website livestock monitoring.

Based on the results obtained from this research, in order to develop research so that it is even better, namely the website itself cannot be accessed globally for further research, global domains can be used so that it can be accessed by anyone.

REFERENCES

- [1] Noviardi, A. Budiman, R. Mulya Dan H. Efendi, "Rancangan Alat Ukur Tubuh Ternak Untuk Menentukan Berat Badan Ternak Sapi Menggunakan Arduino Berbasis Android," *Jurnal Simtika*, Vol. 13, No. 2, Pp. 47-54, 2021.
- [2] W. G. Wiriasto, Misbahudin, S. M. Iqbal, S. A. Rachman, I. S. L. A Dan B. Djulfikri, "Alat Penimbang Hewan Ternak Elektronis Bagi Komunitas Ternak Di Kecamatan Ampenan," *Prosuding Pkm-Csr*, Vol. 1, 2018.
- [3] S. Hadi S, A. Hamdan Dan A. Subhan, "Optimasi Formulasi Pakan Sapi Potong Dengan Menggunakan Linear Programming Model," *Jurnal Pengembangan Penyuluhan Peternakan*, Vol. 16 (30), Pp. 17-24, 2019.
- [4] M. K. N. A. S. A. S. S. M. K. R. Effendi, "Iot Smart Agriculture For Aquaponics And Maintaining Goat Stall System," *International Journal Of Integrated Engineering*, Vol. 12 No. 8, Pp. 240-250, 2020.
- [5] D. Susanto, "Analisis Perwilayahan Dan Strategi Pengembangan Peternakan Kambing Di Kabupaten Lumajang," 2017.
- [6] M. S. N. M. A. P. S. S. M. Kaur, "Rfid Technology Principles, Advantages, Limitations & Its Application," *International Journal Of Computer And Electrical Engineering*, Vol. 3, No. 1, Pp. 1793-8163, 2011.
- [7] S. W. A. T. Ghozali, "Nrf 24101 Sebagai Pemancar/Penerima Untuk Wireless Sensor Network," *Jurnal Tekno*, Pp. 26-34, 2020.
- [8] K. S. A. K. S. N. Akhyar, "Analysis Of Water Quality Around The Coast Based On Physical Parameters (Temperature, Salinity And Metal Content) Using," *International Journal Of Scientific Research In Science, Engineering And Technology*, Pp. 295-300, 2020.
- [9] R. A. T. A. S. S. P. Roys, "Perancangan Aplikasi Penjualan Hewan Ternak Untuk Qurban Dan Aqiqah Dengan Metodeunified Modeling Language (Uml)," *Jtech*, Pp. 31-40.
- [10] K. J. Parhusipa, "Rancang Bangun Aplikasi Penjualan Ternak Bumdes Berbasis Website," *Jurnal Keilmuan Dan Aplikasi Bidang Teknik Informatika*, Pp. 152-163, 2021.
- [11] Prayoga, "Rfid," *Electrical Engineering*, Senin Juli 2021. [Online]. Available: <https://Te.Umtas.Ac.Id/2021/07/05/Rfid/>. [Diakses 2 Agustus 2022].
- [12] T. A. A. S. S. P. R., "Perancangan Aplikasi Penjualan Hewan Ternak Untuk Qurban Dan Aqiqah Dengan Metodeunified Modeling Language (Uml)," *Jtech*, Pp. 31-40, 2021.
- [13] M. B. A. B. D. S. M. Mubaro, "Model Otomatisasi Monitoring Kandang Untuk Peternakan Kambing Berbasis Arduino Mega," *Science Electro*, Vol. 13, No. 2, 2021.
- [14] R. B. W. F. A. & L. U. Rusdi, "Budidaya Kambing Etawa Di Jorong Padang Ambacang Nagari Batu Balang Kecamatan Harau Kabupaten Lima Puluh Kota," *Suluah Bendang: Jurnal Ilmiah Pengabdian Kepada Masyarakat*, Pp. 80-91, 2019.
- [15] F. I. T. R. I. F. Sembiring, "Pengaruh Efektivitas Pemasaran Online Terhadap Tingkat Penjualan Hewan Ternak Kambing (Suatu Kasus Di Pt. Jawara Banten Farm Desa Waringinkurung Kecamatan Waringinkurung Kabupaten Serang)," *Doctoral Dissertation, Universitas Sultan Ageng Tirtayasa*, 2019.